



Leica ES2
Leica EZ4
Leica EZ4 HD
Manual

Congratulations!

You have just purchased a Leica E Series stereomicroscope - an excellent choice! The Leica E series is perfectly suited for practical instruction in schools and universities as well as for routine tasks in the laboratory and industrial production and testing. Viewing entire objects under magnification imparts perspectives and discoveries that would not be possible with the naked eye.

In developing our stereomicroscopes, we have placed great emphasis on simple, self-explanatory operation. However, please take the time to read the instruction manual and the notes on operating safety, to learn about all the features and capabilities of your instrument so that you can use it safely and to its best advantage. Should you have any questions, please consult your local Leica representative. We are gladly at your service!

Chapter Overview

Safety and Use	6
Leica ES2	10
Leica EZ4 and Leica EZ4 HD	18
Eyepieces (only for Leica EZ4)	29
Photography Using the Leica EZ4 HD	37
The Camera Menu	51
Care and Transport	62
Specifications	64
Dimensions	67

Table of Contents

Leica ES2

Overview: Leica ES2	11
Transport, Placement and Storage	12
The Correct Interpupillary Distance	13
Using the LED illuminator	14
Focusing	15
Magnification Display	16
Adjusting the Resistance of the Focus Drive	17

Leica EZ4 and Leica EZ4 HD

Overview: Leica EZ4	19
Instrument variant: Leica EZ4 HD	20
Transport, Placement and Storage	21
The Correct Interpupillary Distance	22
Switching on the LED Illuminator	23
Controlling the Automatic Shutoff	24
Illumination types	25
Focusing	26
Magnification Display	27
Adjusting the Resistance of the Focus Drive	28

Eyepieces (only for Leica EZ4)

Changing Eyepieces (Only for Leica EZ4, Open Version)	30
Eyepieces and Eyecups (Only for Leica EZ4, Open Version)	31
Dioptic Correction (Only for Leica EZ4, Open Version)	32
Graticules (Only for Leica EZ4, Open Version)	34
Graticules: Preparation	35
Inserting the Graticules	36

Photography Using the Leica EZ4 HD

Leica EZ4 HD: Overview of the instrument	38
General Instructions	39
Introduction	40
Standard delivery	41
HD mode and PC mode	42
Capturing Images without a Computer in HD Mode	43
High-resolution Video Display without a Computer (HD mode)	45
PC Mode: Use with a Computer	46
PC Mode: Limitations	47
PC Mode: Additional Use of a HDMI Device	48
Configuring the White Balance	49
Restoring Factory Settings	50

Contents (Continued)

The Camera Menu

Optional Remote Control	52
Viewing Images and Movies with the Optional Remote Control	53
Calling up the Camera Menu	54
COLOR (Automatic White Balance)	55
COLOR (Manual White Balance)	56
EXPOSURE	57
RESOLUTION	58
SETUP CAMERA (Camera Settings)	59
SETUP USER (User-defined Settings)	60
Predefined Illumination Scenarios	61

Care and Transport

Care and Transport	63
--------------------	----

Specifications

Camera Module	65
---------------	----

Dimensions

Leica ES2	68
Leica EZ4 HD	70
Leica EZ4, 10× Eyepieces	72
Leica EZ4 without Eyepieces	74

Safety and Use

Safety Notes



Before installing, operating or using the instrument, it is mandatory to read this user manual. In particular, please observe all safety instructions.

The "Safety Concept" brochure contains additional safety information regarding service work, requirements and the handling of the microscope, accessories as well as general safety instructions.

You can combine individual system articles with articles from external suppliers. Please read the user manual and the safety requirements of the supplier.

To maintain the unit in its original condition and to ensure safe operation, the user must follow the instructions and warnings contained in these user manuals.

Warning of a danger



This symbol indicates especially important information that is mandatory to read and observe. Failure to follow these instructions may pose hazards to personnel, cause instrument malfunctions or damage the instrument.

Hazardous electrical voltage



This symbol indicates especially important information that is mandatory to read and observe. Failure to follow these instructions may pose hazards to personnel, cause instrument malfunctions or damage the instrument.

Important information



This symbol indicates additional information or explanations that intend to provide clarity.

EC Declaration of Conformity

Electrically operated accessories are constructed based on the state of the art of technology and are provided with an EC Declaration of Conformity.

Contact address

*Leica Microsystems (Switzerland) Ltd.
Industry Division
Max Schmidheiny Strasse 201
CH-9435 Heerbrugg (Switzerland)*

Instructions for Use

Intended use

The E Series microscopes are optical instruments for improving the visibility of objects through magnification and illumination. It is used for observing and documenting.

Place of use

Use the instrument in enclosed, dust-free rooms at +10 °C to +40 °C only. Protect it from oil, chemicals and extreme humidity. It must be at least 10 cm from the wall and away from flammable substances.

Interference

Avoid large temperature fluctuations, direct sunlight and vibrations. These conditions can distort measurements and micrographic images.



In warm and warm-damp climatic zones, the individual components require special care in order to prevent the build-up of fungus.

Use in clean rooms

Leica E Series microscopes can be used in clean rooms without any problems.

Handling electrical components



Never install any other plug (NEMA 5-15P) or unscrew any mechanical components unless expressly instructed to do so in the instructions.



The microscope must be connected to a grounded outlet.



Always position the microscope so that you can disconnect it from the power supply at any time. The power cable is provided as the power disconnect device.

Instructions for Use (Continued)

Intervention from the user



The microscopes of the E Series contain no components that can be maintained or repaired by the user. Exceptions are mentioned specifically in this manual.



Unless otherwise specified in this manual, repair and service work may be carried out by authorized Leica technicians only.



Unauthorized alterations to the instrument or noncompliant use shall void all rights to any warranty claims.

Maintenance



Leica E Series microscopes are basically maintenance-free. To ensure that it always operates safely and reliably, we recommend that you take the precaution of contacting the responsible service organization. Here you can arrange for periodic inspections and conclude a maintenance contract (recommended).

Accessories

Only those accessories may be used that are listed in this user manual or for which safe use has been confirmed by Leica Microsystems.

Danger of infection



Direct contact with eyepieces is a potential transmission method for bacterial and viral infections of the eye. The risk can be kept to a minimum by using personal eyepieces for each individual or detachable eyecups.

Leica ES2

Overview: Leica ES2



- 1 *10× fixed eyepieces for eyeglass wearers*
- 2 *Carrying handle*
- 3 *Two-level magnification changer 10× and 30×*
- 4 *Focusing drive*
- 5 *Integrated LED incident light illumination*
- 6 *Integrated LED transmitted illumination*
- 7 *Switch for incident and transmitted light*

Transport, Placement and Storage

Built-in carrying device



All Leica E Series microscopes are equipped with a carrying handle for convenient and safe transport.



Setting up the microscope

1. Place the microscope on a flat tabletop.
2. Connect the power supply to a grounded socket.



Packing the device away

1. After use, wind up the cable as shown in the illustration.
2. Store the instrument so that it is protected against dust.



The Correct Interpupillary Distance

The Ideal Image

 The interpupillary distance is correctly set if you see a single circular image field when looking at a specimen.



You may need a short time to become familiar with using the instrument. Not to worry—after a little while, it will become automatic.

Note for eyeglass wearers

 If you wear glasses, fold the eyecups back – otherwise, fold the eyecups forwards.

Setting the eye distance

1. Look into the eyepieces.
2. Hold the eyepieces with both hands. Push the eyepieces together or separate them until you see a circular image.



Using the LED illuminator

Illuminating the specimen

1. Position a specimen in the middle of the baseplate.
2. Switch the two LED illuminators on or off as desired.

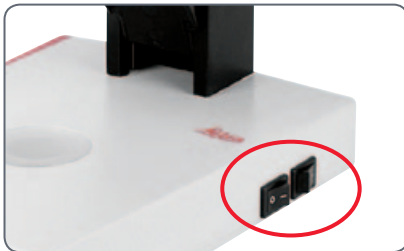

After switching off, the LEDs remain lit for about another 4 seconds.

Tips on use

- Use incident light for plastic, opaque objects.
- Use transmitted light for transmitted light specimens or transparent objects.
- Use the combination of both LED illuminators for partially transparent objects.

Focusing

 Focusing raises and lowers the stereomicroscope using the focusing drive. The specimen is brought into sharp focus as soon as it is in the focal point of the objective.

The focusing drive can be operated either left- or right-handed.

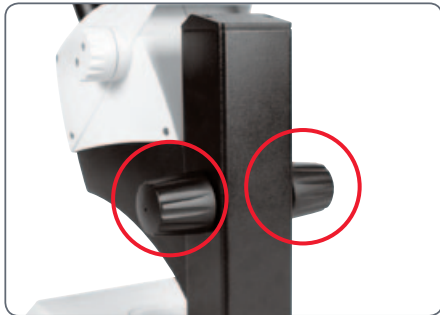

Focusing drive torque

Focusing

1. Set the magnification changer to the lowest level (10).



2. Set the working distance to approx. 100 mm for coarse focusing.



3. Set the magnification changer to the second level (30).
4. Use the focusing drive once again for fine focus.

 After you have adjusted the image sharpness at high magnification, it is maintained even if you switch to a lower magnification (parfocal).

Magnification Display

 You can read the configured magnification on the right-hand rotary knob of the Leica ES2. The additional magnification provided by the eyepieces is already incorporated in the scale.



Adjusting the Resistance of the Focus Drive

Adjusting the resistance

Is the focusing drive too easy or too difficult to adjust? No problem - the resistance can be adjusted individually depending on your personal preferences:

1. Grip the drive knobs with both hands and turn them towards each other until the desired resistance is reached during focusing.

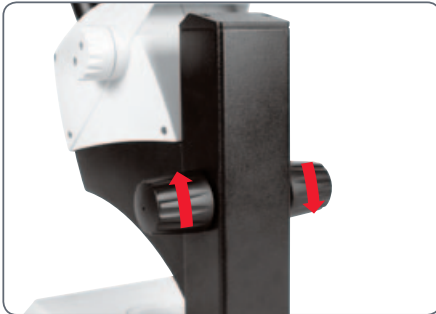

Leica EZ4 and Leica EZ4 HD

Overview: Leica EZ4



- 1 *10x fixed eyepieces for eyeglass wearers*
- 2 *Carrying handle*
- 3 *Magnification changer*
- 4 *Focusing drive*
- 5 *Integrated LED incident light illumination*
- 6 *Illumination control*
- 7 *Integrated LED transmitted illumination*

Instrument variant: Leica EZ4 HD



- 1 10x fixed eyepieces for eyeglass wearers
- 2 Integrated digital camera with SD card slot
- 3 Carrying handle
- 4 Magnification changer
- 5 IR receiver for optional remote control
- 6 Focusing drive
- 7 Integrated LED incident light illumination
- 8 Illumination control
- 9 Integrated LED transmitted illumination

Transport, Placement and Storage

Built-in carrying device



All Leica E Series microscopes are equipped with a holder for convenient and safe transport.



Setting up the microscope

1. Place the microscope on a flat tabletop.
2. Connect the power supply to a grounded socket.



Packing the device away

1. After use, wind up the cable as shown in the illustration.
2. Store the instrument so that it is protected against dust.



The Correct Interpupillary Distance

The Ideal Image

 The interpupillary distance is correctly set if you see a single circular image field when looking at a specimen.

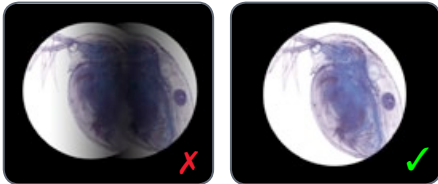

You may need a short time to become familiar with using the instrument. Not to worry—after a little while, it will become automatic.

Note for eyeglass wearers

 If you wear glasses, fold the eyecups back – otherwise, fold the eyecups forwards.

Setting the eye distance

1. Look into the eyepieces.
2. Hold the eyepieces with both hands. Push the eyepieces together or separate them until you see a circular image.



Switching on the LED Illuminator

Automatic shutoff

 If the illumination is not operated for 60 minutes, it switches off automatically. The illumination can be reactivated by pressing a button on the membrane keypad.

LED illumination

1. Position a specimen in the middle of the baseplate.

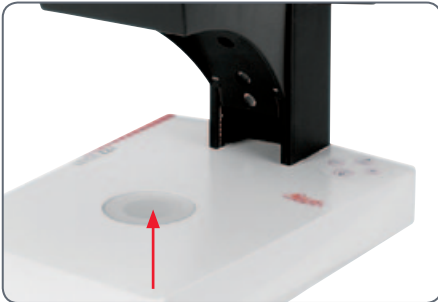

2. Switch the two LED illuminators on or off as desired:

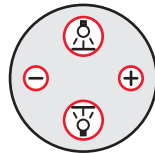

- Use incident light for plastic, opaque objects
- Use transmitted light for transmitted light specimens or transparent objects.
- Use the combination of both LED illuminators for partially transparent objects.



For a detailed description of the illuminator, refer to [page 25](#).

Controlling the Automatic Shutoff



Automatic shutoff



The factory settings of the EZ4 models switch the instrument off automatically after one hour without user interaction. This automatic shutoff helps to conserve the light-emitting diodes and save energy.

Disabling the automatic shutoff



To disable the automatic shutoff, follow these steps:

1. Switch the microscope off.
2. Press and hold the  and  buttons on the light control unit simultaneously while you switch on the microscope.

The LEDs flash twice slowly and then remain switched on. The automatic shutoff is now disabled.

Enabling the automatic shutoff

To re-enable the automatic shutoff, follow these steps:

1. Switch the microscope off.
2. Press and hold the  and  buttons on the light control unit simultaneously while you switch on the microscope.

The LEDs flash three times slowly and then remain switched on. The automatic shutoff is now re-enabled.

Illumination types

Three-level incident light illumination

i The incident light illumination is made up of 5 LEDs. Two, three or five diodes are switched on depending on the level. Accordingly, the angle of incidence of the light beam on the object is switched from high to low.

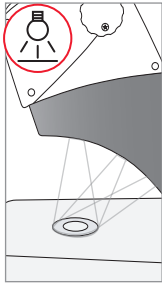

Press 1x
Five diodes: greatest brightness for incident light objects

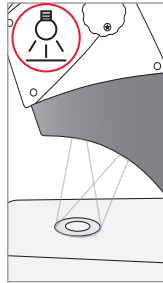

Press 2x
Top three diodes: shadowless uniform lighting for objects with highly uneven surfaces

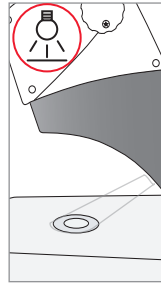

Press 3x
Two diodes: side light emphasizes structures and increases the contrast

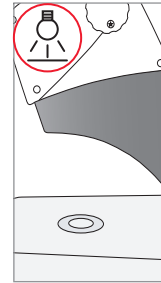

Press 4x
Incident light off

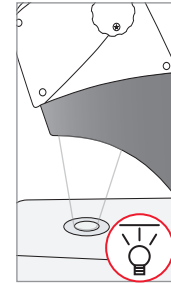

Press 1x
Switch on transmitted light for transparent objects and transmitted light specimens.

Regulating brightness

The brightness is adjusted using the \ominus and \oplus keys and affects all switched-on LEDs.

Focusing

 Focusing raises and lowers the stereomicroscope using the focusing drive. The specimen is brought into sharp focus as soon as it is in the focal point of the objective.

The focusing drive can be operated either left- or right-handed.

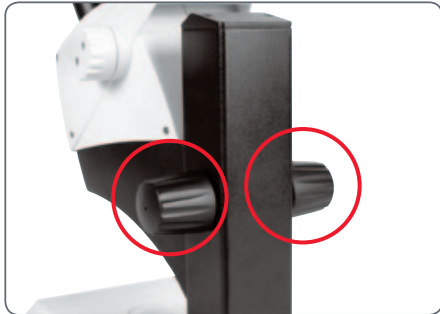

Focusing drive torque

Focusing

1. Set the magnification changer to the lowest level (8).



2. Set the working distance to approx. 100 mm for coarse focusing.



3. Set the magnification changer to the second level (35).
4. Use the focusing drive once again for fine focus.

 After you have adjusted the image sharpness at high magnification, it remains constant even if you switch magnification levels (parfocal).

Magnification Display

 You can read the configured magnification on the right-hand rotary knob of the Leica EZ4 models. The additional magnification provided by the eyepieces is already incorporated in the scale



Leica EZ4 models with open tubes

 On the EZ4 model without eyepieces, only the magnification factors of the magnification changer are indicated: 0.8, 1, 1.25, 1.6, 2, 2.5, 3, 3.5.

 Different total magnifications are possible depending on which eyepieces are used with the EZ4. The magnification of the eyepieces is indicated on their outer surfaces, e.g. 10×/20, 16×/16 or 20×/12.

Adjusting the Resistance of the Focus Drive

Adjusting the resistance

Is the focusing drive too easy or too difficult to adjust? No problem - the resistance can be adjusted individually depending on your personal preferences:

1. Grip the drive knobs with both hands and turn them towards each other until the desired resistance is reached during focusing.

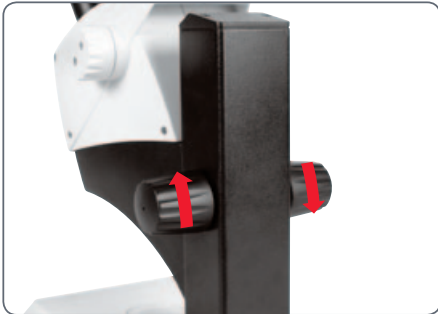

Eyepieces (only for Leica EZ4)

Changing Eyepieces (Only for Leica EZ4, Open Version)

Changing eyepieces

Various eyepieces are available for the Leica EZ4, allowing the stereomicroscope to be adapted even better to the specific requirements.

The following eyepieces are available for selection:

- Eyepieces replaceable, fixed or adjustable: 10×/20, 16×/16 or 20×/12
- Eyepieces for eyeglass wearers 10×/20B and 16×/15B, fixed and adjustable

The interchangeable eyepieces also offer the following advantages:

- The dioptic range is adjustable from +5 to -5
- Measurement graticules can be used, see [page 34](#) and the following.



Adjustable eyepieces for eyeglasses with straight eyecups.

Eyepieces and Eyecups (Only for Leica EZ4, Open Version)

Eyecups

The eyecups can be replaced.

Risk of infection



Direct contact with eyepieces is a potential transmission method for bacterial and viral infections of the eye. The risk can be minimized by the use of individual eyecups.



Eyeglass eyepiece with adjustable diopter and straight eyecups



Eyepiece for users who do not wear eyeglasses with adjustable diopter and inclined eyecup



Fixed eyepiece with inclined eyecup.

Dioptric Correction (Only for Leica EZ4, Open Version)

Dioptric Correction



The adjustable eyepieces for the Leica EZ4 are also available with built-in dioptric correction, allowing the microscope to be used without glasses even by those with vision problems. The correction comprises a maximum of ± 5 diopter settings.



Users with normal vision do not need adjustable eyepieces. An adjustable eyepiece is sufficient for mild shortsightedness.

If vision is extremely poor or when graticules are used, two adjustable eyepieces are needed.

When the diopters are regulated exactly, the sharpness is constant over the entire magnification range (=parfocal).

Once the diopters have been set, the procedure does not have to be repeated. Simply restore your diopter values on the eyepiece before beginning work with the stereomicroscope

Adjusting

1. Set the dioptric correction for both eyepieces to "0".
2. Select the lowest magnification and focus on a flat specimen.
3. Select the highest magnification and readjust the sharpness.
4. Select the lowest magnification again, but do not look into the eyepieces.
5. Carry out steps 6 to 8 for each objective individually.
6. Rotate the eyepiece counterclockwise in the "+" direction as far as it will go (+5 diopter settings).

Dioptric Correction (Continued)

7. Look into the eyepiece.
8. Slowly rotate the eyepiece individually in the "-" direction until the eye sees the object sharply imaged.
9. Select the highest magnification and refocus if necessary.

Now, if you adjust the magnification from the highest to the lowest level, the specimen is always brought into sharp focus. If not, repeat the process.

Graticules (Only for Leica EZ4, Open Version)

Graticules



The transparent graticules can be inserted in the adjustable eyepieces of the Leica EZ4. They enable easy measurements at the specimen.



For equipment with a graticule in one eyepiece, two adjustable eyepieces are needed. Since one eye is focussed on the eyepiece with the graticule, it needs a second, adjustable eyepiece so that it can be aligned optically with the first.

Available eyepiece inserts	
Graticules	10 mm/ 0.1 mm
	5 mm/ 0.1 mm
	5 mm/ 0.05 mm
	100 Div / 0.002"
	100 Div / 0.001"
stage micrometers	150 Div / 0.0005"
	50 mm (0.1 / 0.01 mm graduation)
Crosshairs	1" (0.001" graduation)
	Crosshairs

Graticules: Preparation

Care instructions



The graticule must always be clean and dust-free! Never touch the graticule with bare hands! Always hold the graticule by the edges!

Variant 1: 10× and 20× eyepieces

The 10× and 20× adjustable eyepieces include an insert at the bottom with a snap mount.

1. Gently press the two small tabs on the snap mount together and pull out the insert.



Variant 2: 16× eyepieces

On the 16× adjustable eyepieces, the insert is fixed to the eyepiece by a screwed connection.

1. Screw the insert out counterclockwise.



Inserting the Graticules

Inserting the graticules is the same for all eyepiece types.

1. Place the insert with the knurled side on the work surface.
2. Grasp the graticule so that you see the scale in laterally correct form.
3. Carefully take hold of the edge of the graticule and push it sideways into the holder in the insert. Make sure that both plastic holders snap into place.



4. Put the insert back into the eyepiece. Depending on the variant, you have to either press or twist the insert into place.



5. Insert the eyepiece into the tube.



6. Align the graticules by turning the eyepiece in the tube.



Photography

Using the Leica EZ4 HD

Leica EZ4 HD: Overview of the instrument

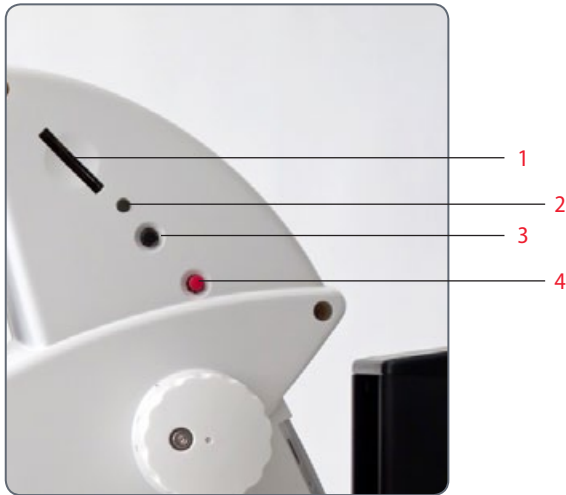

- 1 *SD card slot*
- 2 *Status LED*
- 3 *Black multifunction button*
- 4 *Red multifunction button*

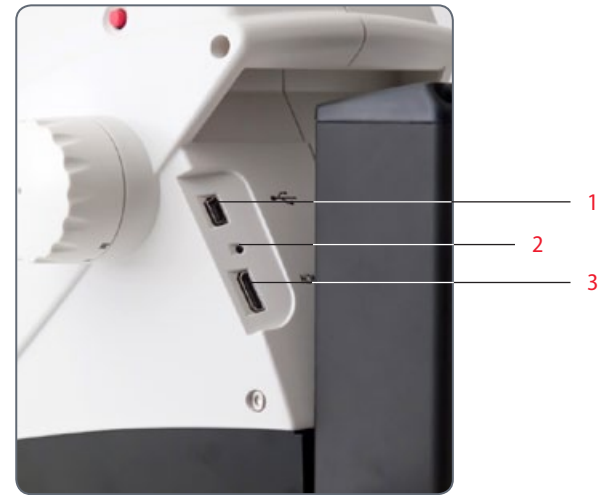

- 1 *USB connection*
- 2 *Pinhole switch*
- 3 *HDMI connection*

General Instructions

General Instructions

- The software for control is included on the DVD provided with the instrument.
- Install the software before connecting the Leica EZ4 HD to the PC or Mac.
- As soon as the EZ4 HD is connected to a power cable and the main switch is turned on, the integrated camera is also ready for use.
- If a USB cable is not connected and there is no SD card in the card slot of the Leica EZ4 HD, the status LED of the instrument lights up RED.

Introduction

The Leica EZ4 HD puts some extremely interesting additional functions at your fingertips. The integrated digital camera is designed for the sole purpose of giving you the best possible quality for your documentation – with particularly easy handling.

Real Full HD display

The integrated HDMI output allows the microscope image to be output to a High-Definition (HD)-capable display unit (monitor, television set or projector), where the following resolutions are possible:

- 1920×1080i ("Full HD"). This resolution provides the best possible imaging performance on a Full HD-capable display unit.
- 1280×720p ("HD ready"). This resolution is suitable for display on televisions labeled "HD ready".

Leica Application Suite EZ

Together with the Leica EZ4 HD, you have also obtained the "Leica Application Suite EZ" software (standard LAS on request). It allows various tasks to be completed in which the television and monitor can even be used together. Thus you are ideally prepared for every situation: work at the computer, presentations, training sessions, trade show appearances, material testing and more.

User-friendly even in the smallest detail

Like every digital camera, that of the Leica EZ4 HD reacts differently to different light sources. However, the white balance is factory-set to match the LED illumination of the microscope. This ensures that you obtain the best results automatically.

Standard delivery



*DVD with Leica software,
drivers and manuals*



USB cable



HDMI cable



SD card



*Optional: Remote control
with battery (Type CR2025)*





Please do not discard any of the packing materials. They should be used for safely storing and transporting the instrument should the need arise.

HD mode and PC mode

The camera is normally in what is known as "HD mode" after being switched on. In this mode, it outputs a high-resolution signal in 16:9 wide-screen format. The images can then be saved directly to an SD card.

If the Leica EZ4 HD is connected to a computer via USB and the Leica software provided is started, the camera switches automatically to what is called "PC mode". In this mode, images are transmitted to the computer with a size of up to 3 megapixels. The aspect ratio is always 4:3.

 If the camera is in PC mode, images cannot be captured directly to an SD card. All images are stored on the PC.

 If the camera is in HD mode, it is not detected by the Leica software. All images are stored on the SD card.

 The microscope remains in the last selected mode (HD or PC mode) until you change it. You can do this automatically by starting the Leica software or manually by pressing and holding the black multifunction button for 5 seconds.

Optional remote control

 You can use the optional remote control only if the camera is HD mode – with the exception of the "i" button, which you can use to show various information on the monitor even in PC mode.

Capturing Images without a Computer in HD Mode

Saving to SD card



Images can be saved directly to an inserted SD card. The card has to be formatted using the "FAT" file system.



When the SD memory card is full, the LED on the camera is illuminated in red. No more images can be captured.

Changing between PC and HD mode



In order to take photos without a computer you must be in HD mode (not PC mode). After the camera is switched on, it is in the last selected mode. However, it switches to PC mode whenever the Leica software is started.

1. To switch between PC and HD mode, press and hold the black multifunction button for 5 seconds.

Detecting the active mode

- The camera is in HD mode when the LED status display is illuminated in red.
- The camera is in PC mode when the LED status display is illuminated in red and flashes green approximately once per second.

Capturing Images without a Computer in HD Mode (Continued)

Capturing an image

1. Insert the SD memory card into the SD card slot until you hear it click into position.
2. Press the red image capture button briefly. You hear an audible signal as confirmation and the camera LED flashes green.



The LED illuminates in green. The camera is now ready to save images to the SD card.



You will hear another beep when the Leica ICC50 HD has completed capturing the image. The image is now saved on the SD card.

High-resolution Video Display without a Computer (HD mode)

Cables

1. Connect the camera and the HDMI device via the integrated HDMI port.

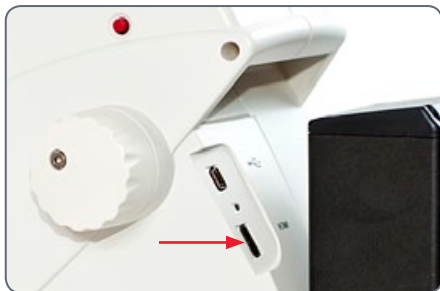

The HDMI cable required for this purpose is included in the standard delivery of the Leica EZ4 HD.



Live images and captured images can be output in high resolution via the HDMI cable:

- Full HD: 1920×1080 pixels
- HD ready: 1280×720 pixels
- Movie: 720×480 pixels

Changing the Resolution

The output resolution (Full HD or HD ready) is configured directly on the microscope.

1. Press a pin into the pinhole switch in order to change the resolution.



PC Mode: Use with a Computer

 For instructions on operating the instrument in PC mode, refer to the DVD included in the standard delivery of the Leica EZ4 HD.

 The 10× eyepieces of the Leica EZ4 HD have a field of view of 20 mm. Unlike the circular object field through the eyepieces, the image section of the camera is rectangular and has a diagonal measurement of 16.4 mm. Therefore, the image field of the camera is smaller than the visible object field through the eyepieces.



 The LED changes color from yellow to red. You can now start the software. Once you have done so, the LED flashes yellow briefly, then stays steady green.

3. Follow the instructions in the software for adjusting and acquiring an image.

Installing and Connecting

1. Place the DVD provided into the computer's disk drive and follow the instructions for loading the software.
2. Connect the camera and the computer using the USB cable.



PC Mode: Limitations

Aspect ratio

 If the Leica EZ4 HD is connected to a computer and is in PC mode, images are always output in a 4:3 size ratio and in a lower resolution – even if a 16:9 monitor or television set is connected via HDMI. The image is necessarily compressed on such a device.

In this case, we recommend that you not connect the television to the microscope, but to the computer as a second monitor.

Remote control

 If the Leica EZ4 HD is in PC mode, the optional remote control cannot be used. The menus of the camera are also no longer displayed on the monitor. Instead, all settings are configured on the computer using the Leica software.





4:3 aspect ratio



16:9 aspect ratio

PC Mode: Additional Use of a HDMI Device

 In PC mode, the camera image is always shown in the preview window of the Leica software. In addition, another computer monitor or television can be connected via the HDMI interface.

 The image resolution on the attached HDMI or television screen is limited to the live image resolution inside the LAS EZ software. Due to technical constraints, it is not possible to send a live image stream to the connected screen in "HD ready" or "Full HD" quality.

 To use a higher resolution on the connected screen, select HD mode on the camera:

1. To switch between PC and HD mode, press and hold the black multifunction button for 5 seconds.

Connecting the HDMI monitor

1. Connect the HDMI cable provided to the camera.



2. Connect the HDMI cable to the HDMI television or monitor.

Configuring the White Balance

 When configuring the white balance of the camera, make sure that no specimen is in the beam path and that a standard illumination is available.

Configuring a New White Balance

Press and hold the red exposure button for 5 seconds. Wait for the beep. As soon as the signal sounds, a new white balance has been configured.



 We recommend carrying out a new white balance adjustment whenever you change the illumination type or color temperature. This is particularly necessary if you are working with an external light source that can be switched from yellow (low intensity) to blue (high intensity). The new white balance generates a neutral background for both types of illuminator.

Restoring Factory Settings

Factory settings

1. Press the red multifunction button for 10 seconds to delete all individual settings and reset the instrument to the factory settings.



The Camera Menu

If you purchased the optional remote, you will have access to the camera menu.

Optional Remote Control



The remote control does not work if the camera is in PC mode.

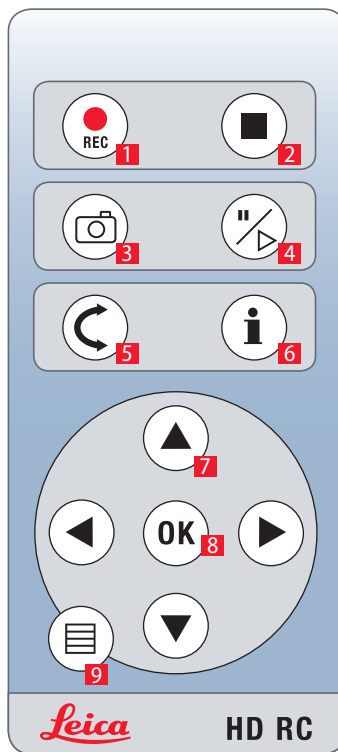







1. Start video recording
2. Stop video recording
3. Save still image to SD card
4. Stop/continue live image
Pause/play movie clip
5. Playback mode
6. Show / hide information box
7. Arrow keys for navigation
8. OK / confirm
9. Call up the camera menu





Viewing Images and Movies with the Optional Remote Control

 If you have purchased the optional remote control, you can display the images and videos captured by the HD camera directly on a HD screen.

1. Miniature view:  (press 1×)

- Select miniature: , ,  and 
- Show full-size image or play back video: 

2. Play back individual image:  (press 2×)

- Previous/next image:  or 
- Play back video: 
- Fast forward/reverse:  or 

3. To return to live view press any button on the camera or press the key 1, 2 or 9 on the remote control (see previous page).

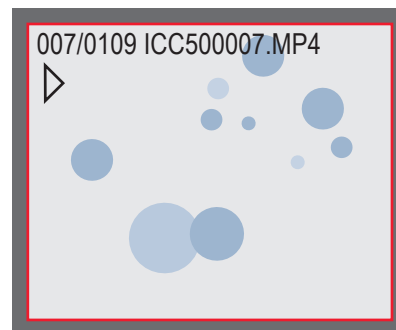

Playback / fullscreen view

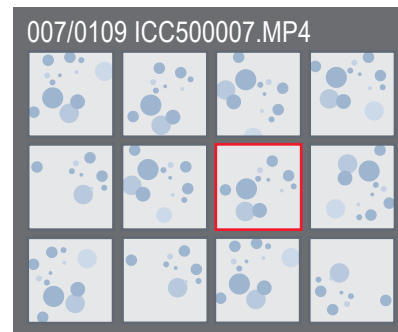





Thumbnail view

Calling up the Camera Menu

 The remote control does not work if the camera is connected to a computer and is in PC mode. The menus of the camera are also no longer displayed on the monitor. In this case, press the black multifunction button for 5 seconds to switch to HD mode (refer also to [page 42](#)).



Opening and closing the camera menu

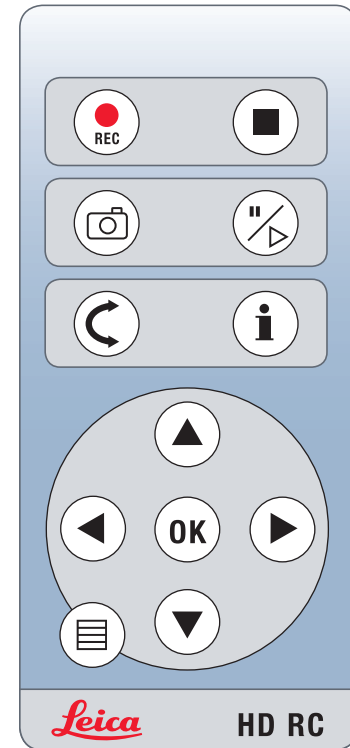

1. Point the remote control towards the microscope.
2. Press the  key on the remote control to show the camera menus on the monitor.
3. Press the   and  buttons to select a menu item.
4. Press the "OK" button to confirm a menu item.
5. Press the  button again to hide the camera menus.



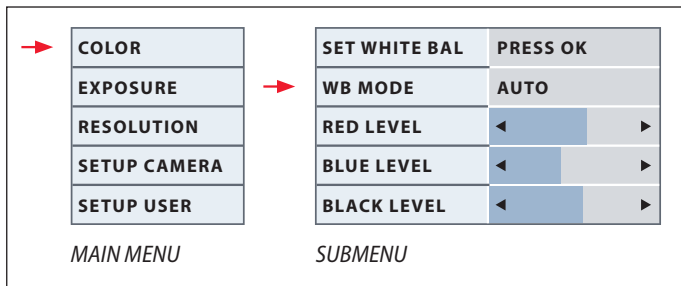

COLOR (Automatic White Balance)



Enabling automatic white balance

1. Press the  button on the remote control.
2. Call up the "COLOR" entry.
3. Set the value for "WB MODE" to "AUTO".
4. Press the  button to exit the menu.

 The "COLOR" function makes it possible to adapt the camera to the ambient light so that color-neutral images can be acquired.



 The values for "RED" and "BLUE" cannot be adjusted if the "WB MODE" setting is set to "AUTO".

 If the "WB MODE" is set to "AUTO", the white balance is carried out continuously. This mode is recommended only for color-neutral specimens and those stained over a wide area.

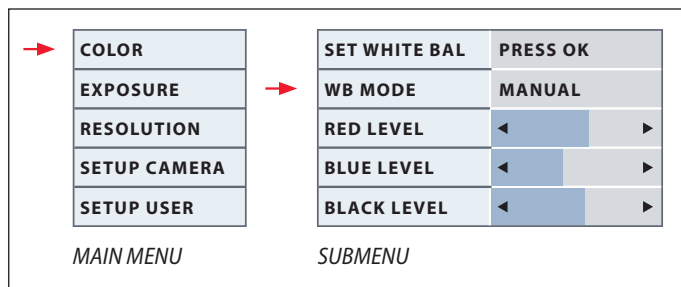
COLOR (Manual White Balance)



Adjusting the white balance manually (recommended)

1. Move the specimen out of the field of view so that only the illumination is seen.
2. Press the  button on the remote control.
3. Call up the "COLOR" entry.
4. Select the "SET WHITE BAL" menu item and press the "OK" button.
4. If necessary, correct the values for "RED" and "BLUE" until the image shows a uniform gray area.
5. Press the  button to exit the menu.



The "COLOR" function makes it possible to adapt the camera chip to the ambient light so that color-neutral images can be acquired.

EXPOSURE

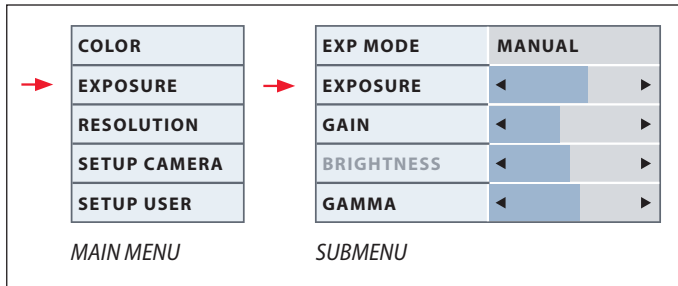

Manual exposure

1. Press the button on the remote control.
2. Call up the command for manual exposure (see diagram at the left).
3. Set the value for "EXP MODE" to "MANUAL".
4. Correct the values for "EXPOSURE", "GAIN" and "GAMMA" until you obtain the desired results.

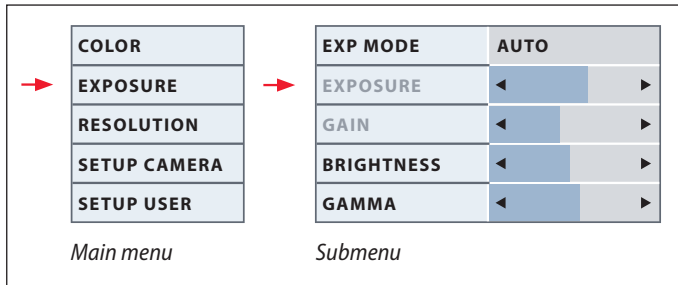

Automatic exposure

1. Press the button on the remote control.
2. Call up the command for automatic exposure (see diagram at the left).
3. Set the value for "EXP MODE" to "AUTO".
4. Correct the values for "BRIGHTNESS" and "GAMMA" until you obtain the desired results.

RESOLUTION

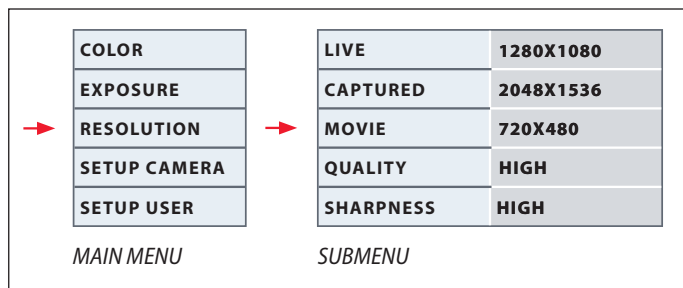

 The "RESOLUTION" menu enables you to define the resolution for the live image on the computer, still image capture and video capture individually. This provides optimum results in every situation.

LIVE (resolution of the live image)

Defines the resolution of the live image. The following resolutions are available:

- For direct connection of the Leica EZ4 HD to a monitor or TV set: 1280×720 or 1920×1080 (16:9 aspect ratio).
- For connection to a computer: 640×480, 1024×768 and 1440×1080 (4:3 aspect ratio)

CAPTURED (resolution of the captured image)

Defines the resolution of the captured image if the Leica EZ4 HD is not connected to a computer. The following resolutions are available: 640×480, 1024×768, 1600×1200 and 2048×1536.

MOVIE (resolution of videos)

Defines the resolution of the recorded videos if the Leica EZ4 HD is not connected to a computer. The resolution is currently limited to 720×480 pixels and cannot be changed.

QUALITY (of the image capture)

A higher image quality can slow down the image capture process. Two quality levels are available for selection: "NORMAL" and "HIGH".

SHARPNESS (internal camera sharpness)

Define the amount of sharpening to be applied to the image.

SETUP CAMERA (Camera Settings)

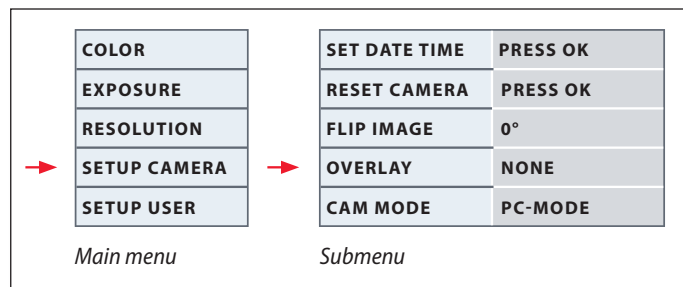

 The camera settings enable you to control internal parameters such as the date or time or to reset the camera. You can also switch the camera from HD mode to PC mode (or vice versa).

SET DATE TIME

This command sets the date and time as well as the format for displaying them. The following formats are available for selection: YYMMDD – DDMMYY – MMDDYY.

RESET CAMERA

This command resets the camera to the factory settings. All user information (such as white balance, resolution etc.) is reset.

FLIP IMAGE

Rotates the live image by 180°.

Overlay

Shows the following on the HD monitor, superimposed over the live image: Leica logo, histogram, date/time and image counter.

CAMERA MODE

This allows you to toggle the camera between PC and HD mode. You can also toggle between PC and HD mode by pressing the black button for more than 5 sec until a message appears on the screen.

SETUP USER (User-defined Settings)

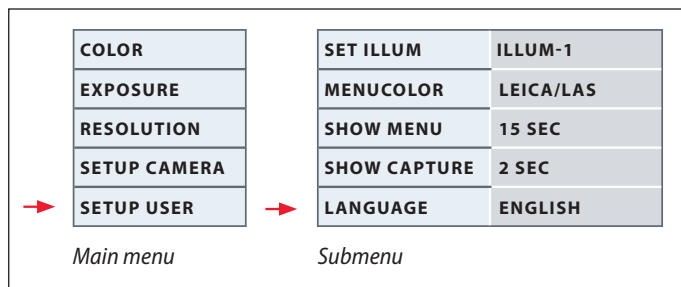

 The user-defined settings enable you to, for example, save illumination scenarios and retrieve them later.

SET ILLUM -1 to 3 (save illumination modes)

These settings allow you to store up to three different illumination modes and retrieve them later. Select the number of the illumination mode and press "OK" to store the current camera settings for later acquisition situations.

SET MENUCOLOR

Currently, two color schemes are available for the menu guidance. Additional colors may be provided in the future via a firmware update.

SHOW CAPTURE

Defines how long an image is displayed on the screen after being captured.

SHOW MENU

Defines how long the menu is displayed on the screen.

SET LANGUAGE

Select the language of the menu.

Predefined Illumination Scenarios

 The camera in the Leica EZ4 HD provides various illumination modes that cover a wide variety of possible situations.

Changing the illumination mode

1. Press the black multifunction button briefly to display the current illumination mode on the monitor or TV set.



2. Press the button again to switch to the next illumination mode.
3. Press the red image capture button or wait until the menu no longer appears.

 To return to the last selected mode, press the black multifunction button several times in succession until the "LAST USED" setting appears.

 If you do not press the black multifunction button for 5 seconds, the selected illumination mode is taken over.





Care and Transport

Care and Transport

General Instructions

- Keeping all optical components clean is important for maintaining good optical performance.
- Always protect the microscope and camera with the plastic cover when the instrument is not in use. (Included in the delivery package of the microscope.) Be sure power to the camera is off when the dust cover is in place.
- If any optical surface becomes badly coated with dust or dirt, it should be cleaned by blowing the surface with a syringe or brushing it off with a camel hair brush before attempting to wipe the surface clean.
- Optical surfaces should be cleaned using a lint-free cloth, lens cloth or cotton swab moistened with a commercially available glass cleaner. Do not use alcohol.
- Avoid excessive use of solvents. The lint-free cloth, lens cloth or cotton swab should be soaked with solvent, but not so wet that solvent runs over the lens.
- Protect the microscope from moisture, fumes and acids and from alkaline, caustic and corrosive materials. Do not store chemicals in the vicinity.
- Protect the microscope from oil and grease. Never grease or oil mechanical parts or sliding surfaces.
- It is advisable to enter a service agreement with Leica Service.

Transport



Always use both hands to carry the microscope. There is a handle on the back of the microscope and an undercut in the front for this purpose.

Specifications

Camera Module

Camera	
Weight	700 g (camera only)
Height	50mm
Exposure time	2 msec – 2 sec
Live image	Max. 45 fps (1256 × 720 px) – 20 fps (1920 × 1080 px)
Full frame image acquisition	2048 × 1536 pixels, 3.1 megapixels
Movie clip	720 × 480 pixels (MP4)
Sensor size	6.55 mm × 4.92 mm
Pixel size	3.2 μm × 3.2 μm
Sensor grade	Micron 1/2" CMOS
Gain	1× to 20×
Color Depth	24-bit
Data format	JPEG / TIFF / BMP / MP4
Operating systems	Windows XP, Windows Vista, Windows 7, Mac OS X
Software available	LAS EZ software (PC), optional LAS modules, Acquire (Mac)
Min. computer config.	Intel Pentium 4 or DuoCore, 2 GHz, 2 GB RAM, 24-bit graphics, 1248 × 1024, DVD
Min. display specification	<ul style="list-style-type: none"> • HD ready (1280×720) • Full HD (1920×1080) • Standard HDMI port*

* Connection via DVI using a HDMI–DVI adapter is not recommended!

Camera Module (Continued)

Mechanical and optical interfaces

- Integrated camera module
- Light distribution Optical 50% / Camera 50%
- Internal video magnification 0.5×
- Sensor Centered to optical axis ± 0.1 mm
- Horizontally / Vertically aligned ± 1 degree

Electronic interfaces

- USB 2.0, mini-USB plug
- Mini-HDMI (HD ready and Full HD)
- LED with 2 colors: green ("ready"), red ("image capture")
- Integrated slot SD (Secure Digital) card
- SD card: 1-8 GB, WIFI, WORM support, High Capacity (HC)
- Black multifunction button for changing the illumination mode (press for 1 second) and for switching between HD and PC mode (press and hold for 5 seconds)
- Red multifunction button for image capture using SD card (press for 1 second), configuring a new white balance (press and hold for 5 seconds), reset camera (press and hold for 10 seconds)

Other

- Power supply: integrated power supply
- Power requirement: 4 W
- Operating temperature range +5 °C to 50 °C
- Relative humidity 10% to 90%
- CE Declaration of Conformity Available
- Tested standards EMI/RFI: EN55011-B EN50082-1
- EMC: 61000-3-2 61000-3-3

Dimensions

Leica ES2

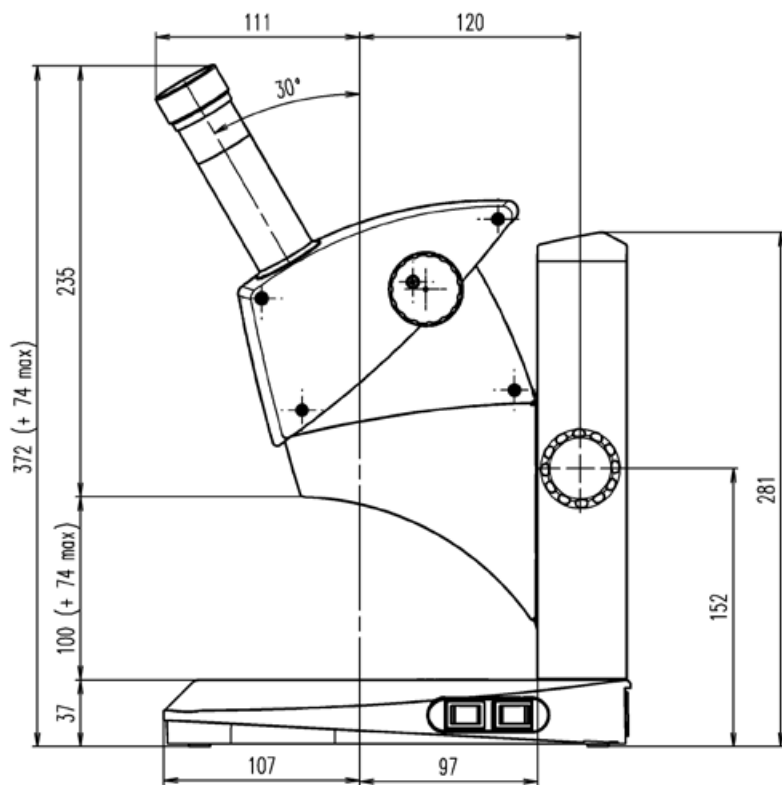

Leica ES2 (Continued)

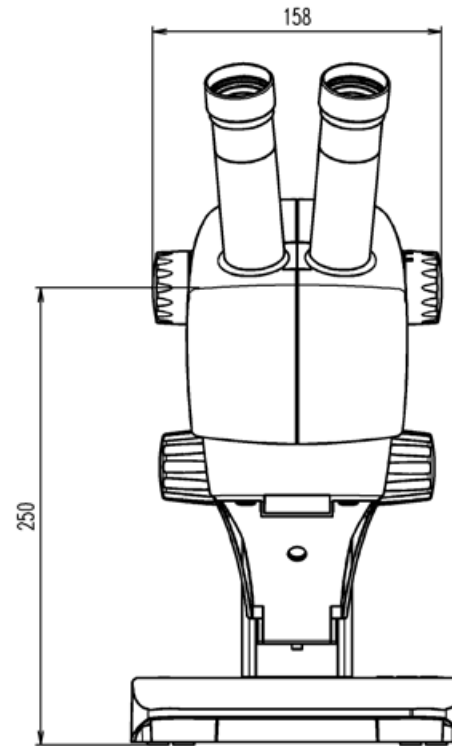
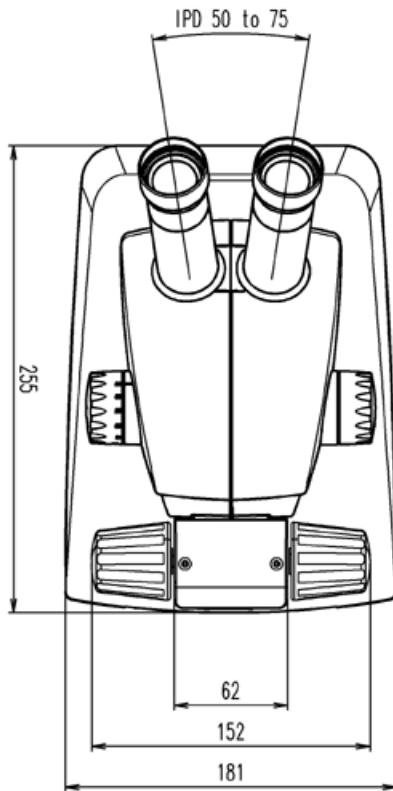

Leica EZ4 HD

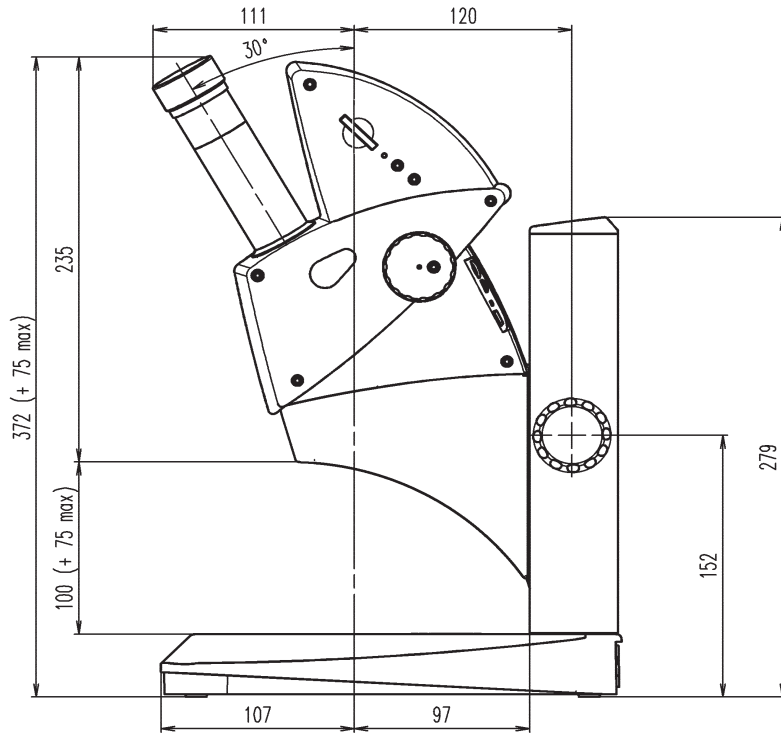

Leica EZ4 HD (Continued)

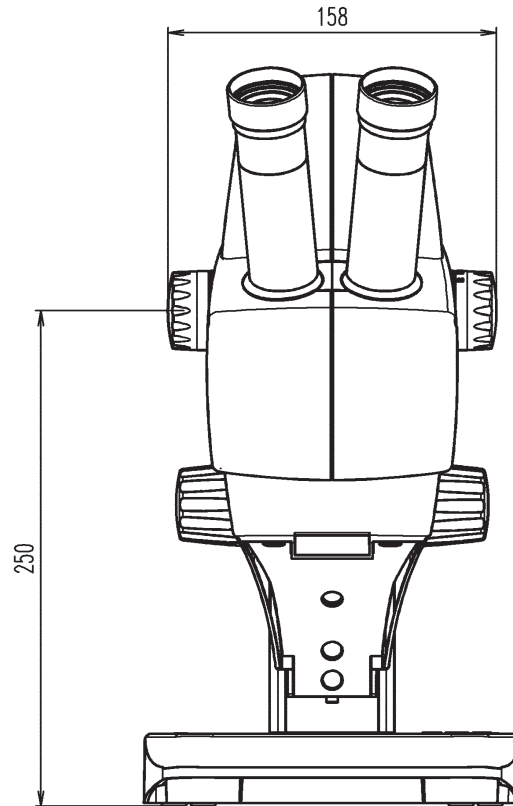
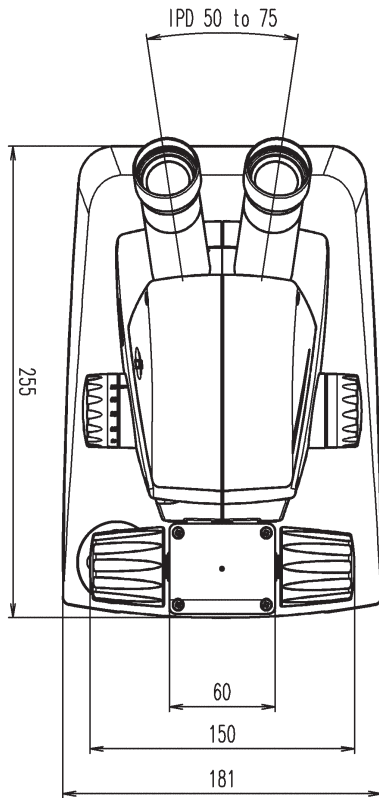

Leica EZ4, 10× Eyepieces

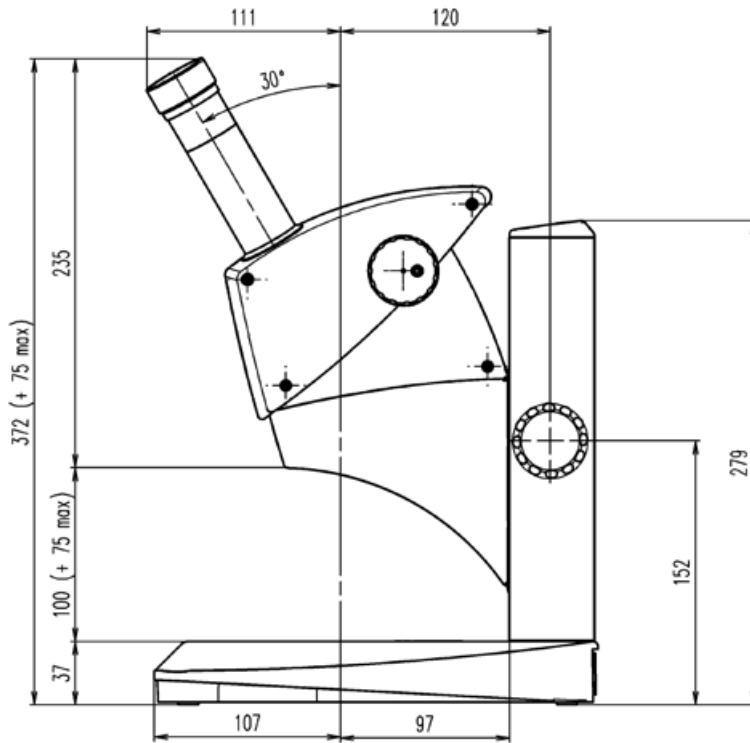

Leica EZ4, 10× Eyepieces (Continued)

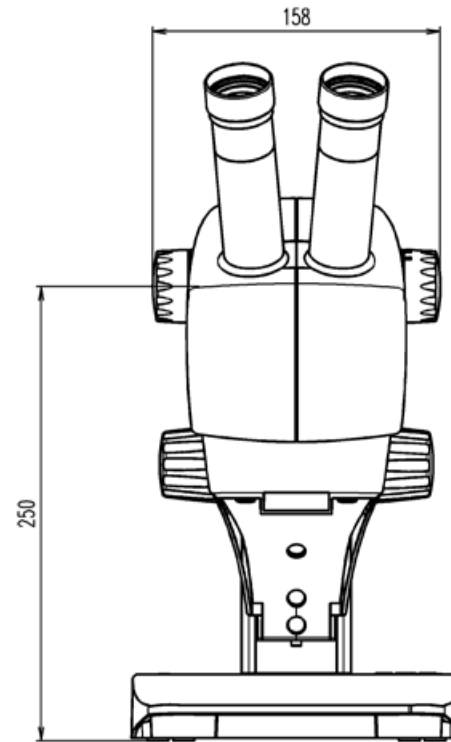
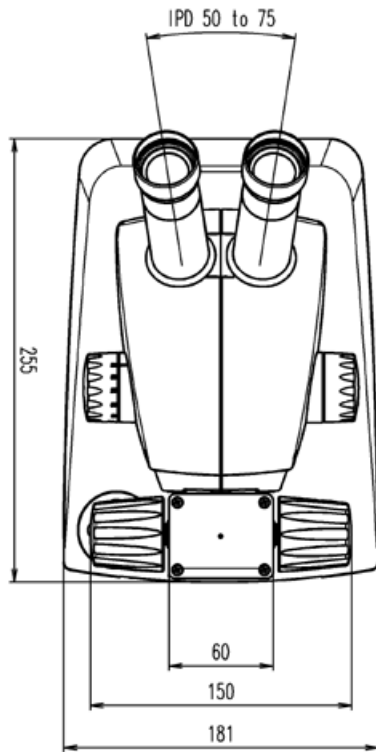

Leica EZ4 without Eyepieces

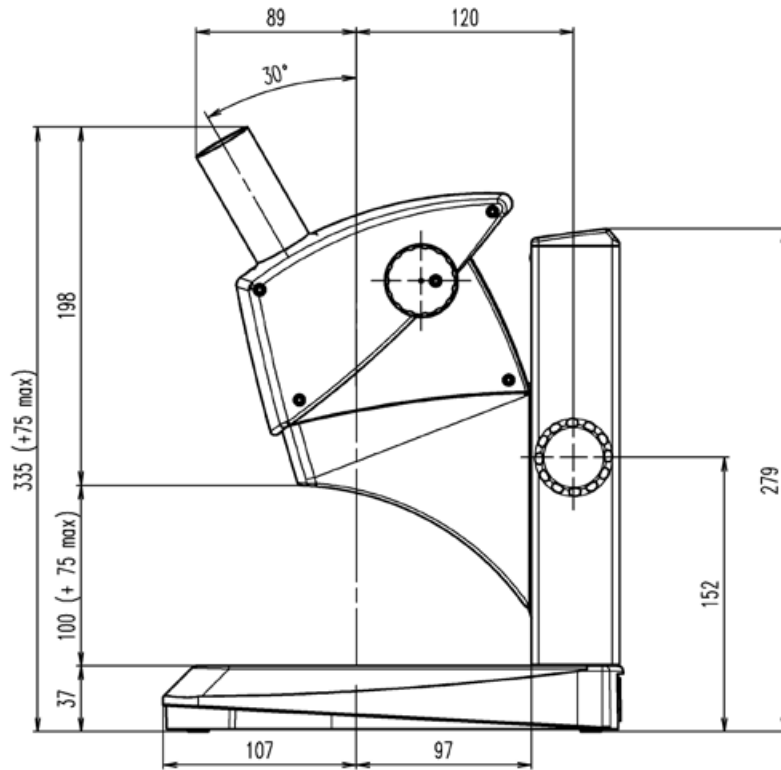

Leica EZ4, without Eyepieces (Continued)

